

MÖDEL	VOLTAJ (V)	FREKANS (Hz)	GÜÇ (W)	AKIM (A)	KON-DANSATÖR (uF)	DEVİR (d/dk)	DEBİ (m ³ /h)	SES SEVİYESİ (dB(A))	AĞIRLIK (kg)
RAD 100	230	50	80	0,30	2,00	2610	250	50	2,6
RAD 125	230	50	80	0,36	2,50	2325	320	55	2,7
RAD 150	230	50	85	0,38	2,50	2385	410	55	3,2
RAD 160	230	50	85	0,0,38	2,50	2385	410	55	3,2
RAD 200	230	50	122	0,55	4,00	2550	810	56	4,8
RAD 250	230	50	145	0,63	5,00	2635	1120	58	5,3
RAD 315	230	50	210	1,10	7,00	2660	1750	65	6,9

MÖDEL	A (mm)	B (mm)	C (mm)	D (mm)
RAD 100	100	208	246	290
RAD 125	100	208	246	290
RAD 150	150	196	270	320
RAD 160	160	196	270	320
RAD 200	200	255	333	380
RAD 250	250	234	331	380
RAD 315	315	283	401	450

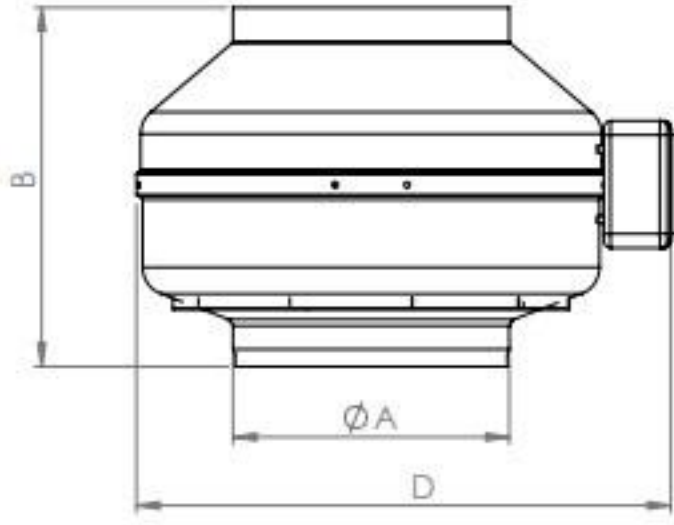

RAD 100

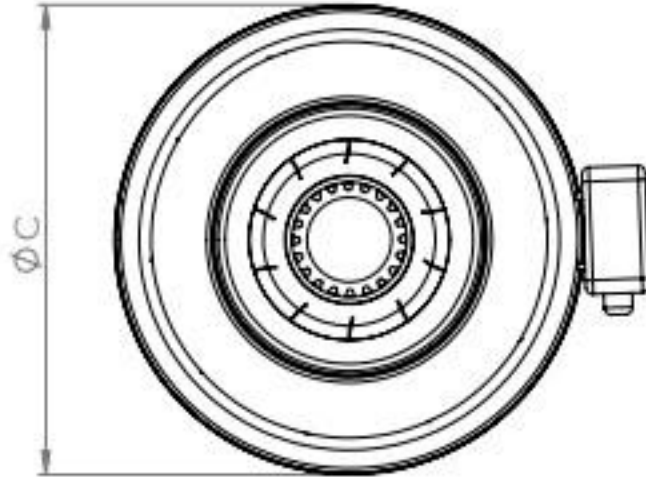
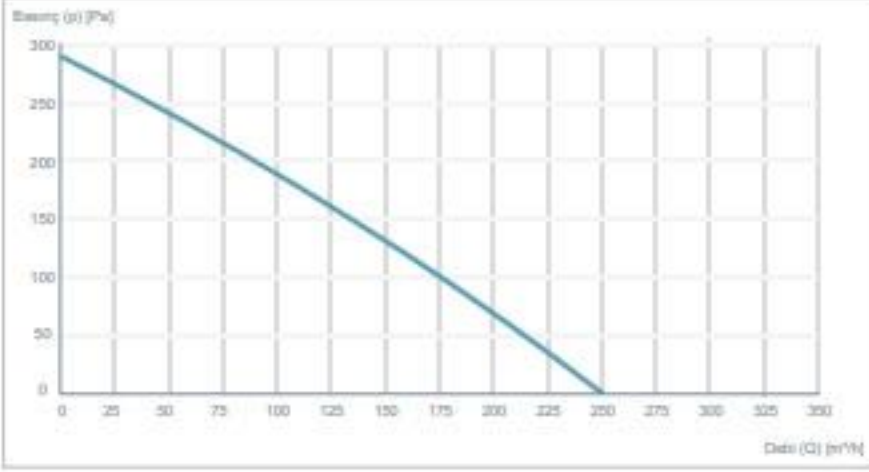

RAD 125

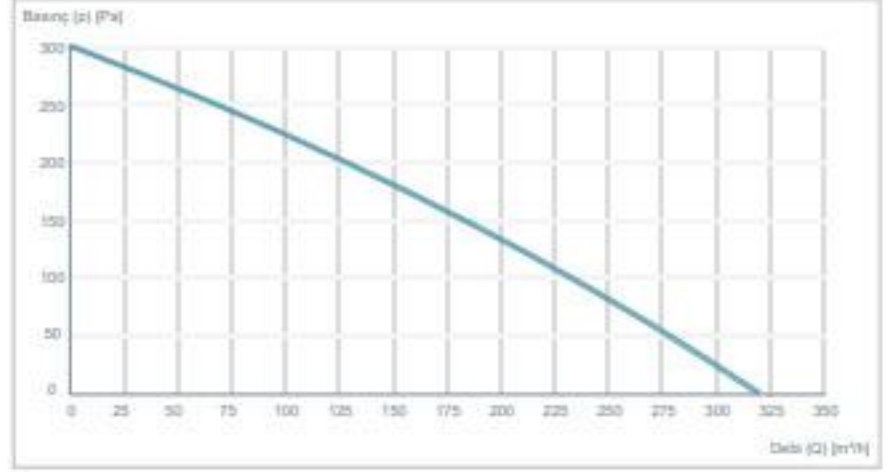

RAD 150

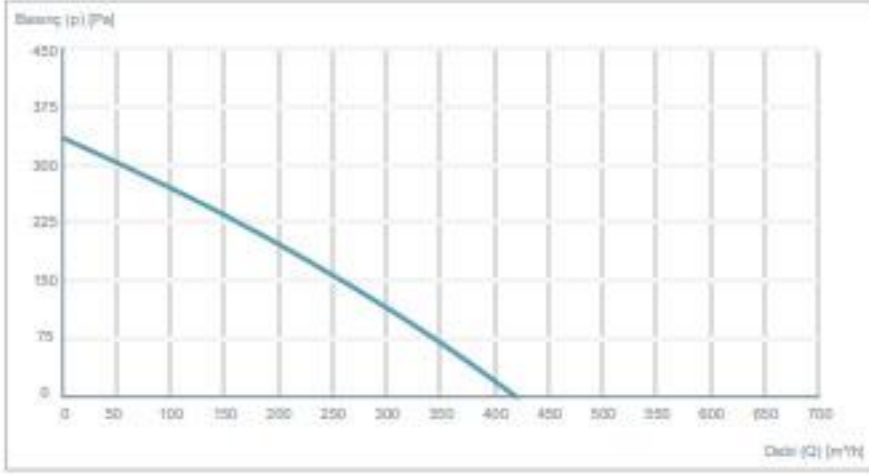

RAD 160

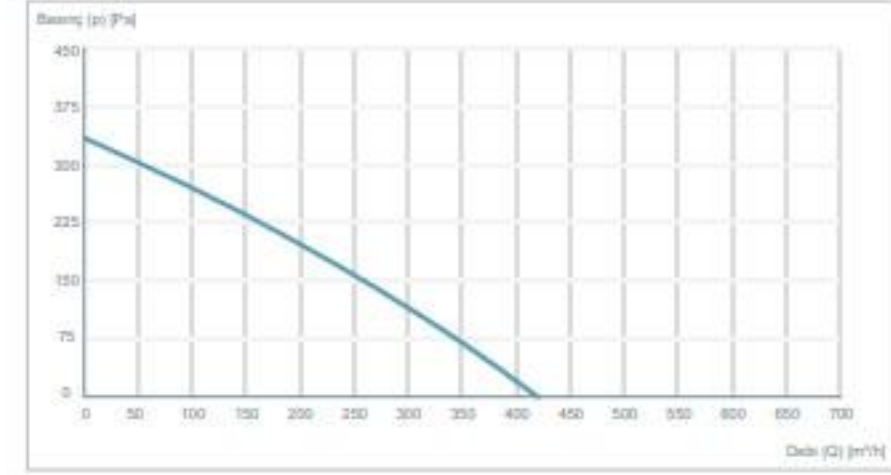

RAD 200

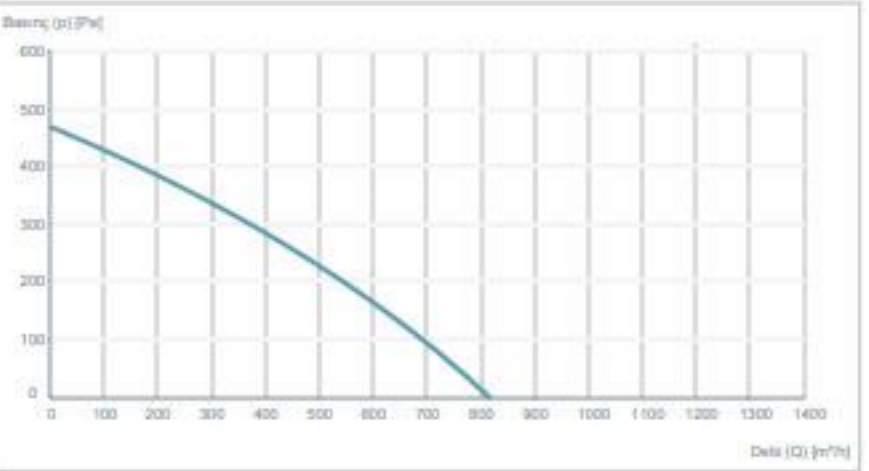

RAD 250

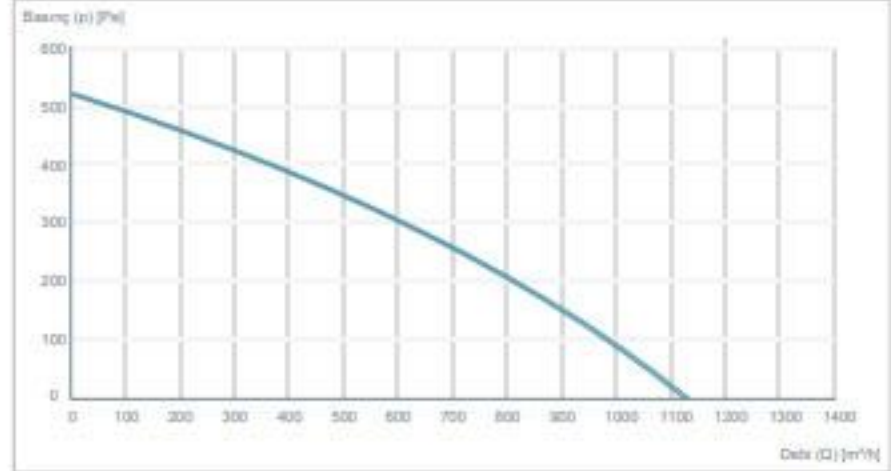

RAD 315

